



NiGLON

Industrial Accessories

ISM404P Metal Clad Rotary Isolator

Technical Drawing

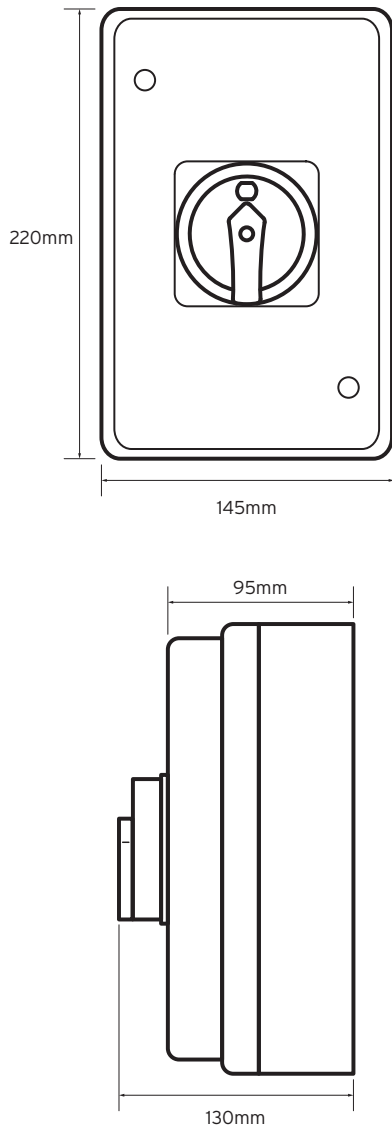

Technical Specifications

Standards	EN60947-3
Rated Current	40A
No. of Poles	4
Rated Insulation Voltage(V)	690V
Rated Operating Current(A)	40
AC-22A	40
AC-23A	40
AC-3	32
Rated Voltage(Ue)	440V
Rated Power Control(KW)	15
Rated short-time withstand current(Icw)	800A
Connect Wire	10mm ²
Screw Torque	1.2 N.m

Enclosure Characteristics

Overall Dimensions HxWxD	220x145x95mm
Depth with switch	130mm
Degree of IP	IP54
Colour	RAL7035

Wiring Diagram

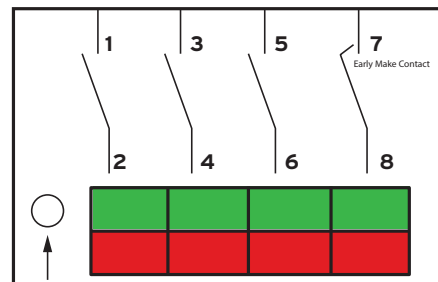

Note 7 = Early Make Contact